

Installation Manual

TOYOTA CH-R 5DR
TOY-CHR-5-A



COMPONENTS INCLUDED

SHADES

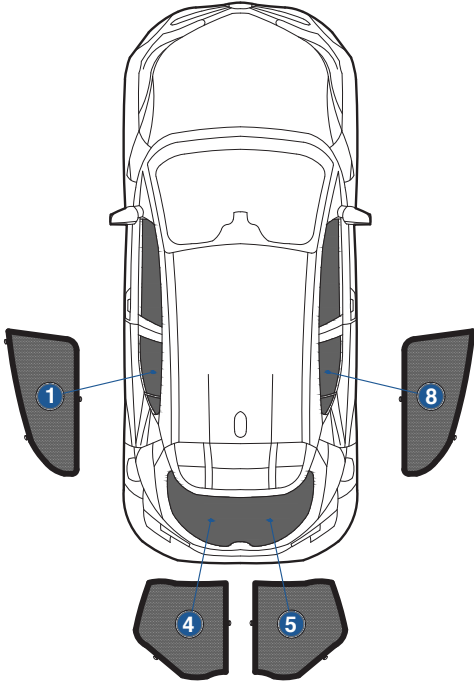

FIXING CLIPS



CL-M02 x 04



CL-M04 x 2



CL-M12 x 4



CL-M13 x 2



CL-M14 x 1

Side Shade Installation

TOYOTA CH-R 5DR
TOY-CHR-5-A

COMPONENTS NEEDED:



STEP #1

ATTACH CLIPS ON SHADE EDGES

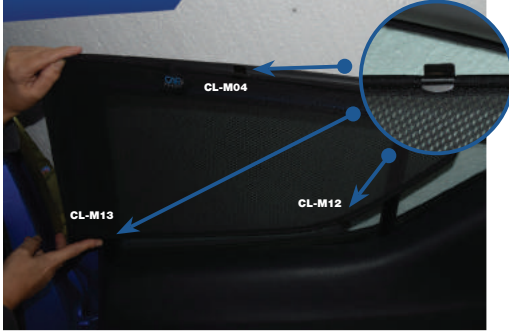

STEP #2

POSITION THE SIDE SHADE

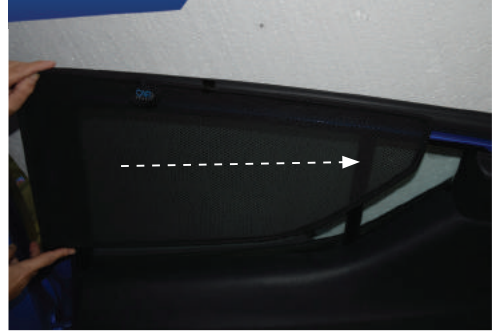

STEP #3

INSERT CLIPS INSIDE WEATHERSTRIP

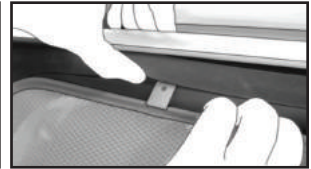

STEP #4

ENSURE SECURELY FITTED IN PLACE

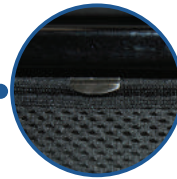
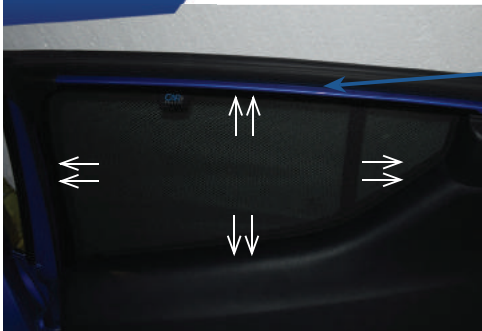

CAR[®]
SHADES

Rear Shade Installation

TOYOTA CH-R 5DR
TOY-CHR-5-A

COMPONENTS NEEDED:



STEP #1

ATTACH CLIPS ON SHADE EDGES

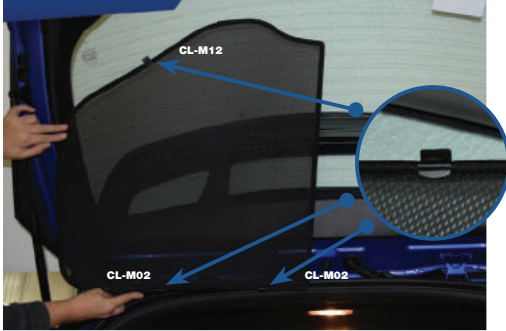

STEP #2

POSITION THE REAR SHADE

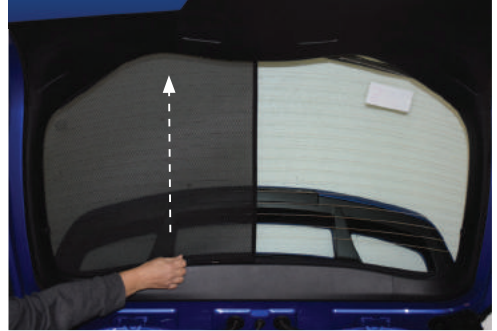

STEP #3

INSERT CLIPS BEHIND INTERIOR TRIM

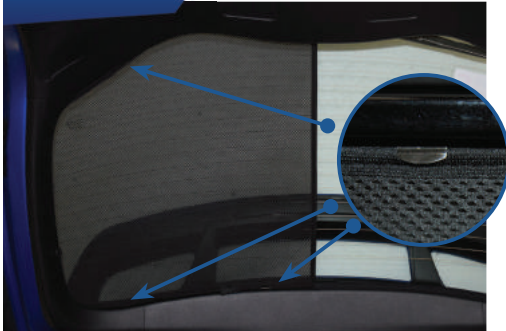

STEP #4

REPEAT THE PROCESS ON OTHER SHADE

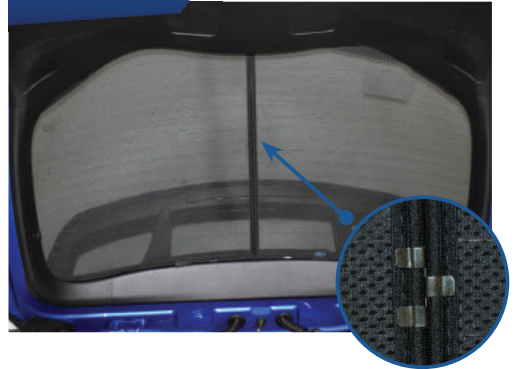

STEP #5

ENSURE SECURELY FITTED IN PLACE

